



Zertifiziertes
QM-System
DIN EN ISO 9001
Zertifikat-Nr. 01017

Liquid Level Switches

according to the tuning fork principle



measuring
•
monitoring
•
analysing

NWS



- Repeatability:
 ± 1 mm
- p_{\max} : 45 bar
 t_{\max} : 130 °C,
150 °C
(for CIP process)
- Connections:
pipe screw joints, NPT,
flange, hygienic thread
- Material:
stainless steel 1.4404
- Viscosity:
max. 5000 mm²/s
- No moving parts
- Insensitive to plant
vibrations
- ATEX version



Level

KOBOLD companies worldwide:

ALGERIA, ARGENTINA, AUSTRALIA, AUSTRIA, BELGIUM, BULGARIA, CANADA, CHILE, CHINA, COLUMBIA, CZECHIA, DOMINICAN REPUBLIC, EGYPT, FRANCE, GERMANY, GREAT BRITAIN, HUNGARY, INDIA, INDONESIA, ITALY, MALAYSIA, MEXICO, MOROCCO, NETHERLANDS, PERU, PHILIPPINES, POLAND, ROMANIA, SINGAPORE, SLOVAKIA, SOUTH KOREA, SPAIN, SWITZERLAND, TAIWAN, THAILAND, TUNISIA, USA, VENEZUELA, VIETNAM

KOBOLD Messring GmbH
Nordring 22-24
D-65719 Hofheim/Ts.
☎ Head Office:
+49(0)6192 299-0
☎ Sales DE:
+49(0)6192 299-500
☎ +49(0)6192 299-23398
info.de@kobold.com
www.kobold.com



Description

The KOBOLD liquid level switch NWS is designed as a 2 and 3-wire switch and can be universally used in vessels and pipelines. The NWS operates on the tuning fork principle in air at resonance frequency. A piezoelectric crystal is used for excitation of oscillations and for monitoring the actual oscillation frequency. When the fork is immersed in liquid, the frequency changes: this change is detected electronically and the output signal is changed. The NWS operates as a two-wire switch in series with the load. The simple electronic switch is operated by the liquid. The NWS can also be connected to a PLC through a third terminal.

Special Features

The NWS has an output state indicator with an LED that can be seen through a lens in the cover. The LED flashes about once a second when the NWS has switched off and is permanently illuminated when the NWS is switched on. The LED is an optical confirmation that the NWS is working correctly and the condition of the wet side is correctly displayed. The NWS can be set as upper or lower limiter with a mode selector.

Applications

- Oils and foamed oils
- Water
- Paints and transparent inks
- Sauces
- Milk
- Liquids containing carbon dioxide

The NWS is ideal for hygienic and sterile applications and for CIP cycles up to 150 °C.

ATEX version:

- Type of protection: intrinsically safe ia
- Designation: II 1G EEx ia IIC T6
- To use in connection with intrinsically safe isolation switching amplifier according to IEC 60947-5-6

Technical Details

Material

Fork: stainless steel 1.4404
 Process connection: stainless steel 1.4404
 Surface finish: $R_a = 0.8 \mu\text{m}$ (for option T,L,H,D)
 Electronic housing: NWS-...200: PA6, glass-fibre-reinforced cover with window, 330° rotatable
 all other types: stainless steel 1.4301

Process connections: pipe thread DIN EN 10226-1, NPT-thread, Tri-Clamp®, pipe connection DIN 11851 (sanitary connection), aseptic-connection DIN 11864, DRD flange, flange B 25 PN 40 DIN 2527, flange B 50 PN 40 DIN 2527, flange ANSI B 16.5 - 1", 300 lbs, flange ANSI B 16.5 - 2", 300 lbs

Protection: plastic housing: IP 65 (NWS-...200)
 stainless steel housing, plug connection: IP 67
 stainless steel housing, cable connection: IP 68

Max. operating pressure: 45 bar
 flange connection: see pressure steps

Max. medium temp.: 130 °C (NWS-...200..) 90 °C (for all other NWS) short-time 150 °C for CIP (valid for all models NWS)

Ambient temperature: -20 °C...+70 °C

Min. immersion depth for switch points: 12 mm (marker on fork)

Power supply

NWS-...200..: 24 ... 240 V_{DC/AC} (50/60 Hz); 2-wire; 24 V_{DC}, 3-wire

NWS-...23/24/2W/2H..: 24 V_{DC}, 3-wire

NWS-...2E..(ATEX): isolation switching amplifier to IEC 60947-5-6 (Namur) necessary (for example: REL-6)

Delay: 1 s wet/dry 1 s dry/wet

Viscosity: 5000 mm²/s max. at 25 °C (influence on the response time)

Hysteresis: 4 mm vertical, 1 mm horizontal

Repeatability: ±1 mm

Weight: 0.5 kg (for R 3/4 and 3/4 NPT)

Electrical Connection

NWS-...200...

2-wire 24-240 V_{AC/DC},
serial load,
I_{max} ≤ 500 mA

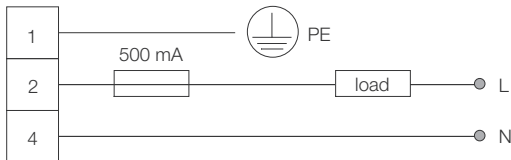

NWS-...200...

3-wire, V_S = 24 V_{DC}
output PNP: U_{HIGH} ~16.5 V;
U_{LOW} ~2,5 V; I_{max} ≤ 500 mA

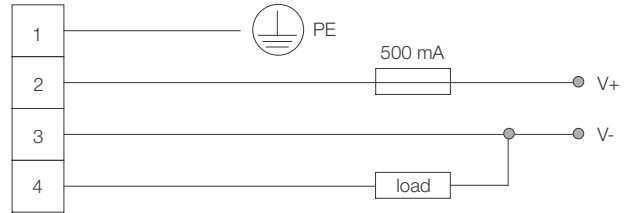

NWS-...23/24 (24 V_{DC})

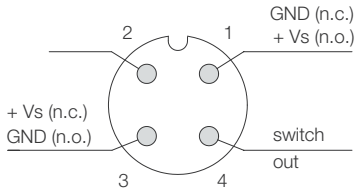

NWS-...2W/2H (WHG in preparation)

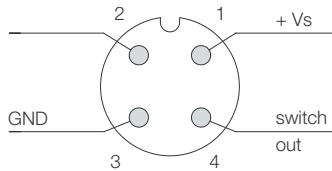

NWS-...2E... (ATEX)

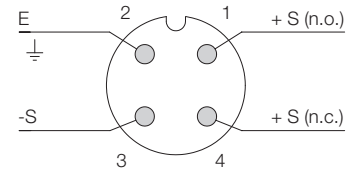

Wiring Diagram

Colour of core	NWS-...23/24	NWS-...2W/2H
brown	+ Vs (n.o.) / GND	+ Vs
blue	GND / + Vs (n.c.)	GND
black	switch out	switch out

Lead-/Pin number	NWS-...2E (ATEX)
1	+ S (n.o.)
2	earth
3	- S
4	+ S (n.c.)

Wiring examples NWS-...2E... with power supply unit acc. to IEC 60947-5-6

Plug M12x1

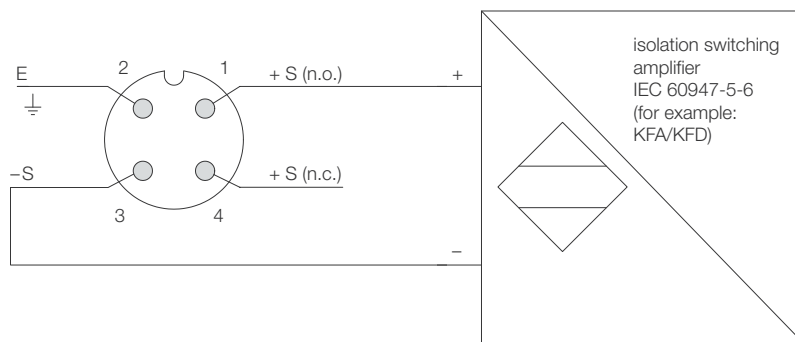

Cable 1,5 m

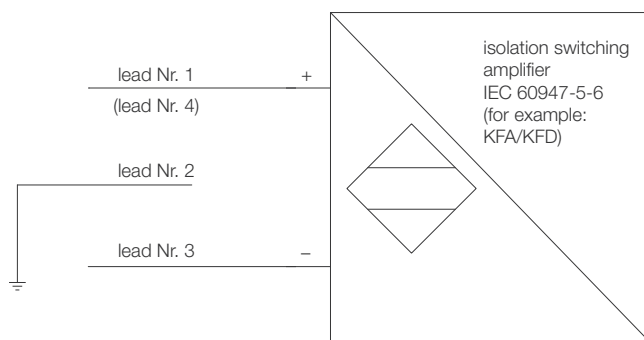

Order Details (Example: NWS-R20 200 0070)

Connection	Model	Electrical connection	Sensor version
R 3/4 AG	NWS-R20...	plastic housing 200 = 24...240 V _{AC/DC} cable gland/terminal connection st. steel housing/plug connection 23S = 24 V _{DC} , PNP, plug M12x1 24S = 24 V _{DC} , NPN, plug M12x1 2WS*** = 24 V _{DC} , WHG, PNP, plug M12x1 2HS*** = 24 V _{DC} , WHG, NPN, plug M12x1 2ES = ATEX approval, plug M12x1 st. steel housing/cable connection 23F = 24 V _{DC} , PNP, 1.5 m cable 24F = 24 V _{DC} , NPN, 1.5 m cable 2WF*** = 24 V _{DC} , WHG, PNP, 1.5 m cable 2HF*** = 24 V _{DC} , WHG, NPN, 1.5 m cable 2EF = ATEX approval, 1.5 m cable	0060 = 60 mm (only for model NWS-T) 0070 = 70 mm standard version, short 0117** = 117 mm extended 0300** = 300 mm sensor 0500** = 500 mm sensor 1000** = 1000 mm sensor XXXX** = please specify special length 4-position in mm (max. 3000 mm)
R 1 AG	NWS-R25...*		
3/4 NPT AG	NWS-N20...		
1 NPT AG	NWS-N25...*		
DIN flange DN 25	NWS-F25...		
DIN flange DN 50	NWS-F50...*		
1" ANSI flange	NWS-A25...		
2" ANSI flange	NWS-A50...*		
Tri-Clamp® DN 40	NWS-T40...		
Tri-Clamp® DN 50	NWS-T50...		
sanitary conn. DN 40 (DIN 11851)	NWS-L40...		
sanitary conn. DN 50 (DIN 11851)	NWS-L50...		
aseptic conn. DN 50 (DIN 11864)	NWS-H50...		
DRD Ø 125 mm flange	NWS-D1Z...		
special connection	NWS-YYY...		

** only models marked with * are available with sensors in extended version.

*** WHG-approval in preparation.

Dimensions

NWS-...200
 24...V_{AC/DC}
 Plastic housing

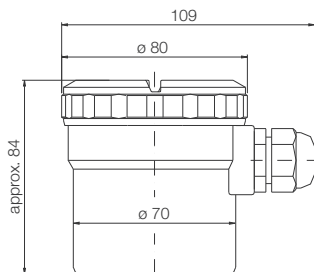

NWS-...23S/24S
NWS-...2WS/2HS
 24 V_{DC}
 Plug connection

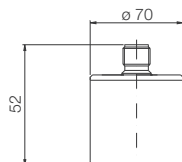

NWS-...23F/24F
NWS-...2WF/2HF
 24 V_{DC}
 Cable connection

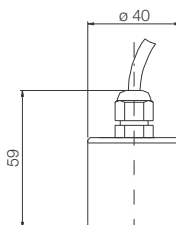

NWS-...2ES
 ATEX
 Plug connection

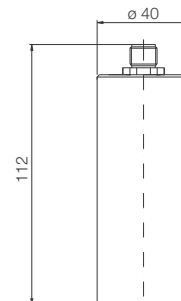

NWS-...2EF
 ATEX,
 Cable connection

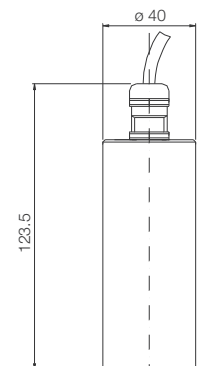

Dimensions (continued)

NWS-...0070
(standard, short)

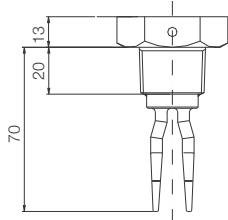

NWS-R25...0117
NWS-N25...0117
(extended)

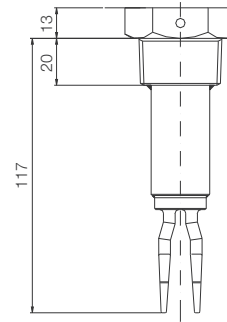

NWS-T...
Tri-Clamp®

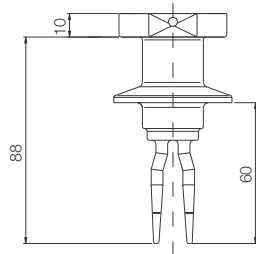

NWS-F... / NWS-A...
Flange version

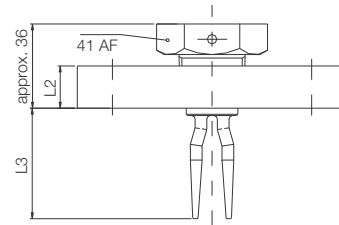

	L 2	L 3
DN 25 / PN 40	18	approx. 47
DN 50 / PN 40	20	approx. 95
ANSI 1" 300 lbs	17.5	approx. 41
ANSI 2" 300 lbs	22.4	approx. 92

NWS-L...
Sanitary
connection
(DIN 11851)

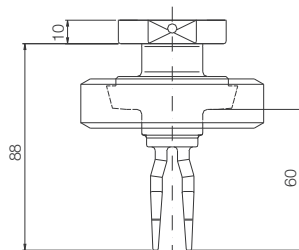

NWS-H...
Aseptic
connection
(DIN 11864)

